



■ 形名

SCONI - AR - PWR20□

● 使用電原

1	AC 110V
2	AC 220V

■ 一般仕様

항 목	Specification	
	110V (1)	220V (2)
Discharge Voltage (peak-to-peak)		
Between Line (L-L)	220 (RMS 205V)	430 (RMS 305V)
Line to ground (L-G)	430 (RMS 305V)	430 (RMS 305V)
Maximum Surge Voltage	(L-L) : 360V (L-G) : 710V	(L-L) : 710V (L-G) : 710V
Response Time (응답속도)	less than 0.1microseconds	
Nominal Impulse Discharge Current	20kA/mode (8 x 20uS) 60kA/Total (8 x 20uS)	
Maximum Load Current	5A	5A
Voltage Drop (전압강하)	less than 2V (50~60Hz)	
Leakage Current (누설전류)		
Between Line (L-L)	less than 1mA @ 150V DC	
Line to ground (L-G)	less than 1mA @ 150V DC	
Rated Voltage (정격전압)	100/110/120V AC	200/220/240V AC
Temp. & Humi. (온도 및 습도)	-40℃ ~ 80℃ / 90% RH	
Weight / Case	95g / Flame-resistant resin (Black)	
부품 소자	UL 승인부품	
특 징	Surge 유입 후 자동복귀 기능	
취부 방법	Rail 혹은 Panel 고정	

■ 特徴

- 이 Model은 부하용량 5A까지의 AC 전원에 연결된 장비를 보호하는데 사용됩니다.
- 정상적인 주파수 (50~60Hz)에 영향을 미치지 않습니다.
- Line Filter를 사용함으로써 낙뢰나 EMI로부터 장비를 보호합니다.
- Power Lamp 표시
- Fuse 내장 (외부교체형)

■ BLOCK 圖

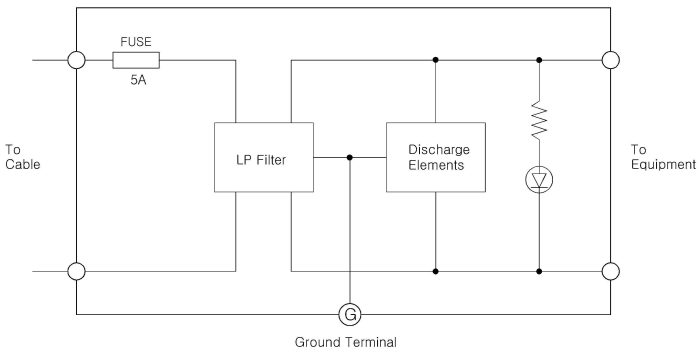

■ 端子接續圖

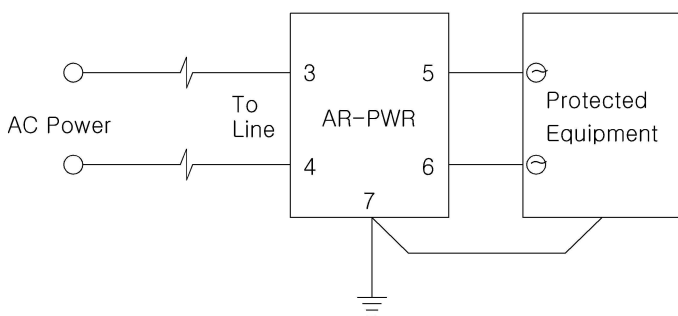

■ 外形 圖

